



63319

LINEA ROUND SNS 2200/840 M1h

8590515633197



- Degree of protection: IP54
- Ambient temperature: 0–25 °C
- Impact strength: IK10
- Life time: 50000 hours
- System efficacy: 131 lm/W
- Colour rendering index CRI: 80-89, 4000–4000 K
- Chromaticity tolerance (initial MacAdam): SDCM3
- Cable glands: rubber
- Protection class: I
- Max. number of luminaires per circuit breaker B16: 93
- Max. number of luminaires per circuit breaker C16: 93
- Flickering value Pst LM: 1
- Power factor: 0,95
- Stroboscope effect value SVM: 0,4
- Total harmonic distortion: 15
- Energy efficiency class of the light source: D

- Body: white polycarbonate (PC, RAL 9003), UV stable, impact resistant
- Diffuser: translucent polycarbonate (PC), UV stable, impact resistant
- Reflector: steel sheet, white (RAL 9003)
- Clips: rotary cap (polyamide + 10 % fibreglass)
- Sealing: polyurethane (PUR), foam-filled base groove
- Connection: screwless five-pole terminal block
- Surface-mount, plastic indoor light fitting for installation onto the ceiling or wall in public or non-public areas
- Opal diffuser made of highly permeable, translucent polycarbonate
- ON/OFF electronic driver (AC, DC on demand), microwave motion sensor, emergency back-up power supply with 1 hour runtime
- Emergency back-up power supply for permanent and emergency lighting, connected to L3 (lum. flux 440lm)

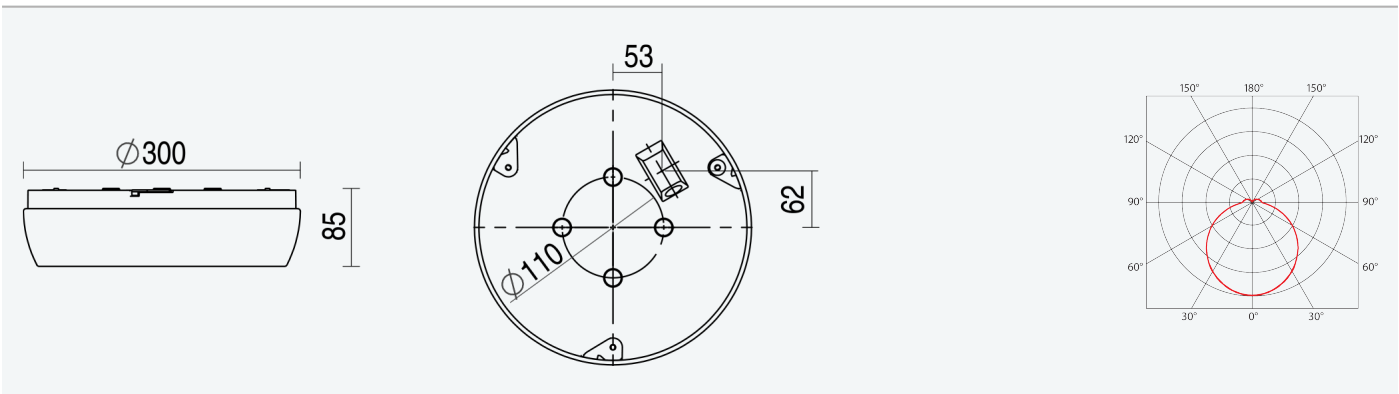

Code	Type	Ta Max.: [°C]	Luminous flux of LED modules [lm]	Luminous flux of light fitting: [lm]	Power consumption: [W]	System efficacy: [lm/W]	Net weight: [kg]
63319	LINEA ROUND SNS 2200/840 M1h	25	2270	1790	13,7	131	1

The values stated for power consumption and luminous flux are in a tolerance of ± 7.5 %

FEATURES



DOWNLOAD





63319

LINEA ROUND SNS 2200/840 M1h

8590515633197

